

# StickIt! Audio I/O Manual

*How to install and use your new  
StickIt! Audio I/O Module*

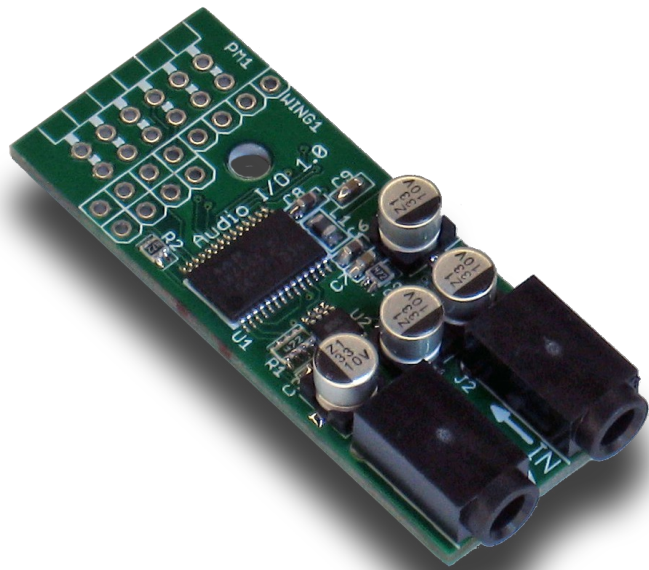

XESS is disclosing this Document and Intellectual Property (hereinafter “the Design”) to you for use in the development of designs to operate on, or interface with XESS hardware devices. XESS expressly disclaims any liability arising out of the application or use of the Design. XESS reserves the right to make changes, at any time, to the Design as deemed desirable in the sole discretion of XESS. XESS assumes no obligation to correct any errors contained herein or to advise you of any correction if such be made. XESS will not assume any liability for the accuracy or correctness of any engineering or technical support or assistance provided to you in connection with the Design.

THE DESIGN IS PROVIDED “AS IS” WITH ALL FAULTS, AND THE ENTIRE RISK AS TO ITS FUNCTION AND IMPLEMENTATION IS WITH YOU. YOU ACKNOWLEDGE AND AGREE THAT YOU HAVE NOT RELIED ON ANY ORAL OR WRITTEN INFORMATION OR ADVICE, WHETHER GIVEN BY XESS, OR ITS AGENTS OR EMPLOYEES. XESS MAKES NO OTHER WARRANTIES, WHETHER EXPRESS, IMPLIED, OR STATUTORY, REGARDING THE DESIGN, INCLUDING ANY WARRANTIES OF MERCHANTABILITY, FITNESS FOR A PARTICULAR PURPOSE, TITLE, AND NONINFRINGEMENT OF THIRD-PARTY RIGHTS.

IN NO EVENT WILL XESS BE LIABLE FOR ANY CONSEQUENTIAL, INDIRECT, EXEMPLARY, SPECIAL, OR INCIDENTAL DAMAGES, INCLUDING ANY LOST DATA AND LOST PROFITS, ARISING FROM OR RELATING TO YOUR USE OF THE DESIGN, EVEN IF YOU HAVE BEEN ADVISED OF THE POSSIBILITY OF SUCH DAMAGES. THE TOTAL CUMULATIVE LIABILITY OF XESS IN CONNECTION WITH YOUR USE OF THE DESIGN, WHETHER IN CONTRACT OR TORT OR OTHERWISE, WILL IN NO EVENT EXCEED THE AMOUNT OF FEES PAID BY YOU TO XESS HEREUNDER FOR USE OF THE DESIGN. YOU ACKNOWLEDGE THAT THE FEES, IF ANY, REFLECT THE ALLOCATION OF RISK SET FORTH IN THIS AGREEMENT AND THAT XESS WOULD NOT MAKE AVAILABLE THE DESIGN TO YOU WITHOUT THESE LIMITATIONS OF LIABILITY.

The Design is not designed or intended for use in the development of on-line control equipment in hazardous environments requiring fail-safe controls, such as in the operation of nuclear facilities, aircraft navigation or communications systems, air traffic control, life support, or weapons systems (“High-Risk Applications”). XESS specifically disclaims any express or implied warranties of fitness for such High-Risk Applications. You represent that use of the Design in such High-Risk Applications is fully at your risk.

© 2013 XESS, Inc. XESS, the XESS logo, and other designated brands included herein are trademarks of XESS Corporation. PMOD is a trademark of Digilent Inc. All other trademarks are the property of their respective owners.



This document is licensed under the Attribution-ShareAlike 3.0 Unported license, available at <http://creativecommons.org/licenses/by-sa/3.0/>.

---

**StickIt! Audio I/O Manual**  
**MAN009 (V1.0) October 14, 2013**

The following table shows the revision history for this document.

Date	Version	Revision
10/14/13	1.0	Initial release for StickIt! Audio I/O module V1.0.

# Table of Contents

- C.1 Preliminaries..... 1**
  - Getting Help!..... 1
  - Take Notice!..... 1
  - Packing List..... 1
- C.2 Setup..... 2**
  - Inserting Your StickIt! Audio I/O Module Into Your StickIt! Board..... 2
    - Inserting Into a PMOD Socket..... 2
    - Inserting Into a Wing Socket..... 3
  - Connecting Audio Cables to Your StickIt! Audio I/O Module..... 4
- C.3 Operation..... 6**
- C.4 Using the Module..... 8**
- A.1 I/O Locations..... 9**
- A.2 Schematic..... 10**

# C.1 Preliminaries

---

Here's some helpful information before getting started.

## Getting Help!

Here are some places to get help if you encounter problems:

- If you can't get the StickIt! Audio I/O module to work, send an e-mail message describing your problem to [help@xess.com](mailto:help@xess.com) or submit a problem report at <http://www.xess.com/help.php>.
- Our web site also has
  - answers to frequently-asked-questions,
  - example designs, application notes and tutorials,
  - a forum where you can post questions.

## Take Notice!

It's pretty hard to get in trouble with this module.

## Packing List

Here is what you should have received in your package:

- a StickIt! Audio I/O module.
- PMOD™ male header.
- Wing male headers (8-pin & 4-pin).

## C.2 Setup

The StickIt! Audio I/O module can both sample and output stereo audio inputs with 20-bits of resolution at 44.1 Khz using a single eight-bit PMOD or a Wing socket on your StickIt! board.

### Inserting Your StickIt! Audio I/O Module Into Your StickIt! Board

#### Inserting Into a PMOD Socket

To use the StickIt! Audio I/O module with a PMOD socket, first solder the included male PMOD header to the module as shown. (**To insure a stable connection, only use a header with 0.025" square pins.**)

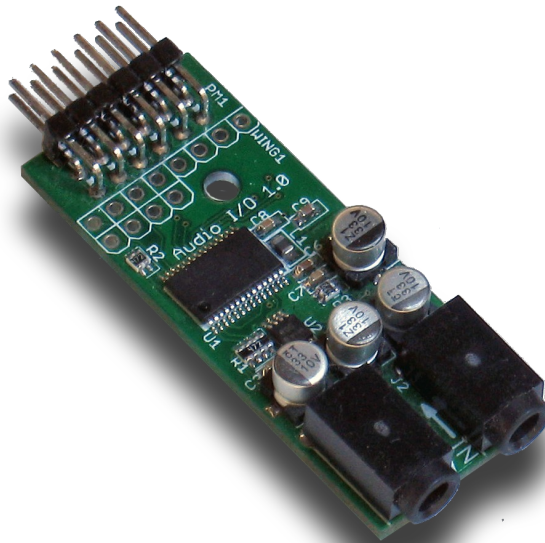

Then insert the module into one of the PMOD sockets on the StickIt! Board.

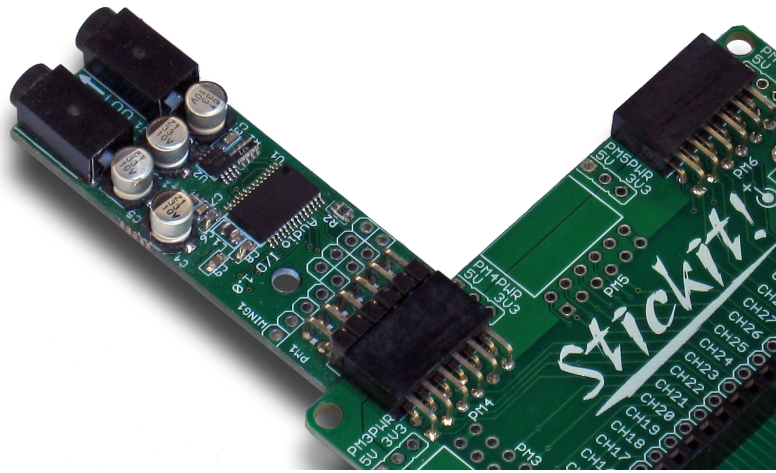

### Inserting Into a Wing Socket

To use the StickIt! Audio I/O module with a Wing socket, first solder the included male Wing headers to the module as shown. (**To insure a stable connection, only use a header with 0.025" square pins.**)

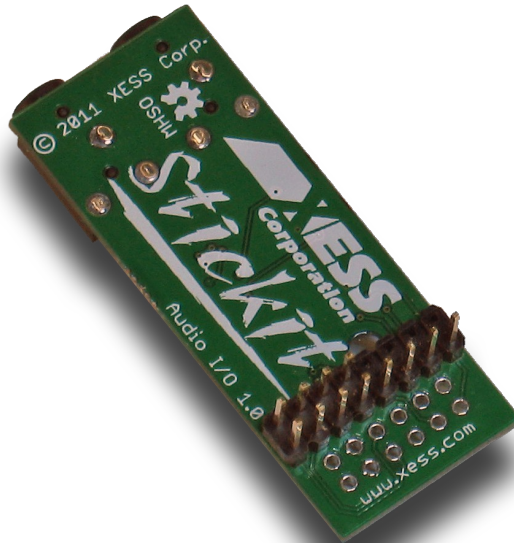

Then insert the module into one of the eight-bit Wing sockets on the StickIt! board.

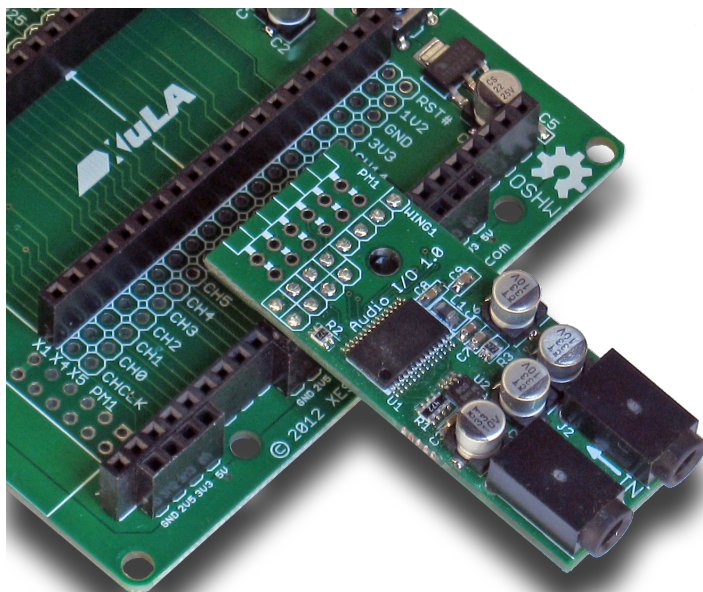

### Connecting Audio Cables to Your StickIt! Audio I/O Module

The StickIt! Audio I/O module accepts mono or stereo audio signals from powered sources (such as the audio line-out port of a computer) or from passive sources (such as a microphone). The input connector accepts a 1/8" (3.5mm) jack as shown below.

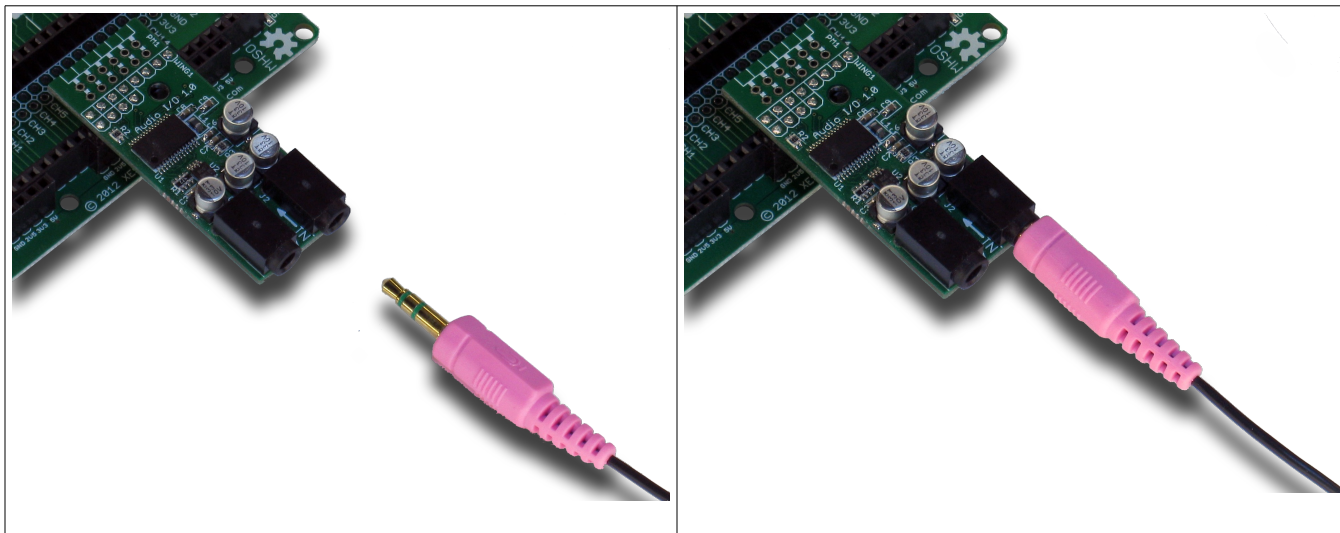



The StickIt! Audio I/O module outputs stereo audio signals that can drive a  $16\Omega$  load such as is found in headphones or powered speakers. The output connector accepts a 1/8" (3.5mm) jack as shown below.

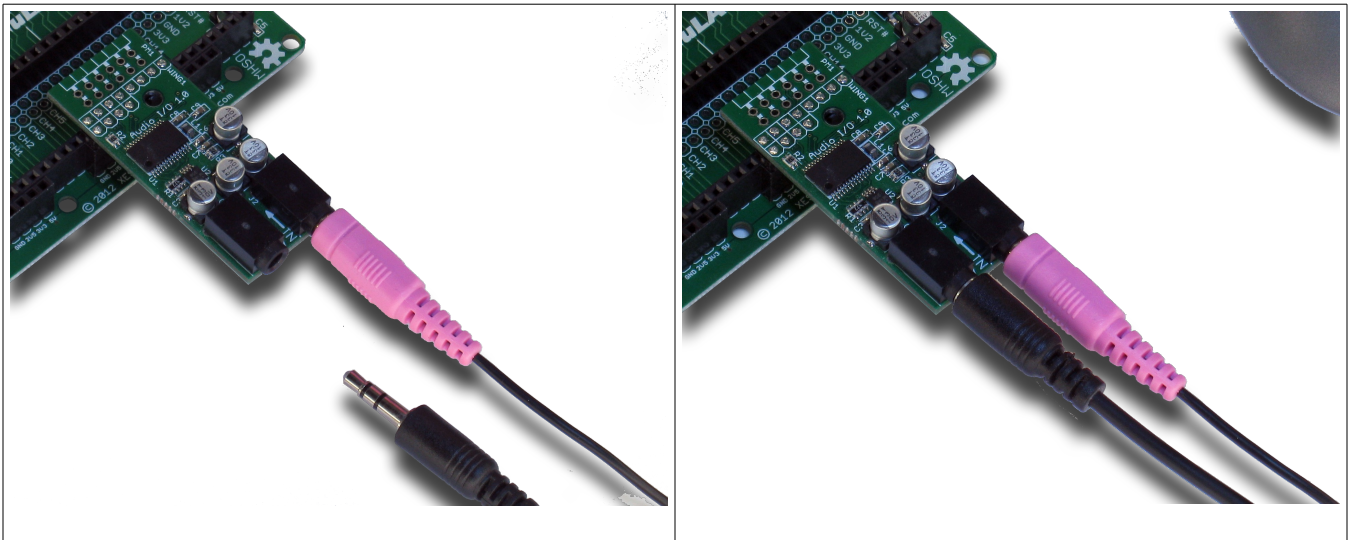

# C.3 Operation

This chapter describes the operation of the StickIt! Audio I/O module using a simplified schematic. You can find a complete [schematic](#) at the end of this manual.

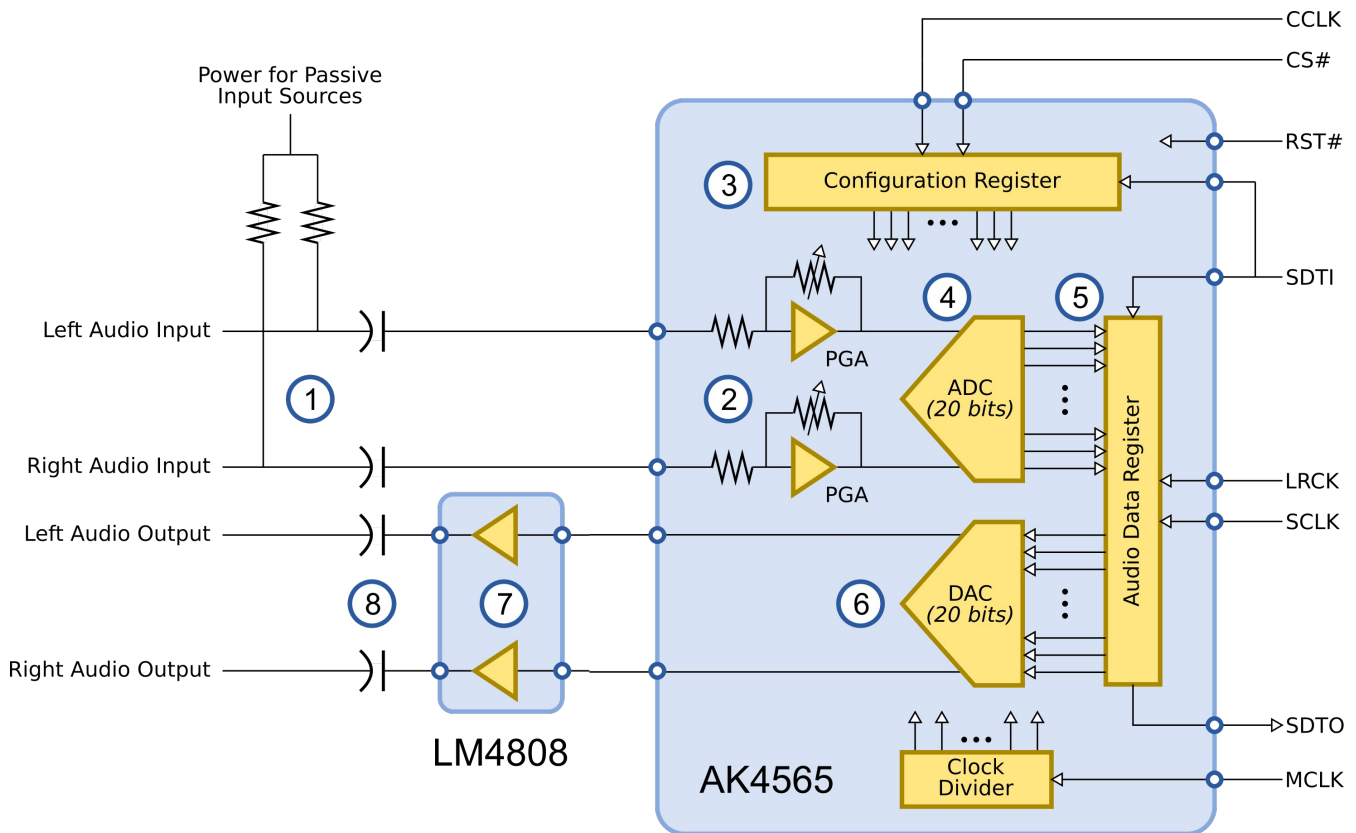

Left and right channels of a stereo audio source enter the StickIt! Audio I/O module at ①. Two pull-up resistors on the stereo inputs provide power if a passive microphone is used for the audio source. Blocking capacitors prevent any DC offset in the audio signal from reaching the input terminals of the AK4565 codec.

Upon entering the codec, the audio inputs are amplified by programmable gain amplifiers (PGAs) at ②. The gain of the PGAs can be set (along with other things) by shifting bits

into the configuration register at ③ using the CS# (chip-select), SDTI (serial data input), and CCLK (configuration clock input). The PGAs allow the codec to work with either small-amplitude signals from microphones or larger signals from powered sources.

The amplified left and right audio signals are digitized into twenty-bit values by the analog-to-digital converter (ADC) at ④. These values are loaded into the audio data register at ⑤ and shifted out of the SDTO (serial data output) pin of the codec using the SCLK (bit-shift clock) and LRCK (left-right channel clock) inputs.

While the digitized input bits are shifted out of the codec, twenty-bit values for the left and right stereo output channels are shifted in through the SDTI input. These bit strings are turned into analog values by the digital-to-analog converter (DAC) at ⑥ and exit the codec.

The two analog output signals are amplified by an LM4808 at ⑦. Any DC offsets in the amplified outputs are removed by the blocking capacitors at ⑧ before exiting the StickIt! Audio I/O module on their way to a powered speaker or headphones.

## C.4 Using the Module

---

To use the StickIt! Audio I/O module, you will need to do the following:

- Create a Xilinx ISE project and allocate seven FPGA outputs to drive the CS#, CCLK, SDTI, RST#, LRCK, SCLK and MCLK inputs and one FPGA input to accept the SDTO output.
- Create an FPGA design that sends serialized configuration bits to initialize the audio codec. Then the design must transfer and receive serialized audio data to/from the codec while keeping up with the 48 KHz sampling rate and maintaining the left/right-channel synchronization. (You'll probably find the datasheet for the AK4565 handy for doing this: <http://www.xess.com/manuals/AK4565.pdf>)
- Attach the module to either a PMOD or Wing socket on the StickIt! board.
- Determine the channel signals on the PMOD or Wing socket that connect to each I/O pin of the module.
- Find which FPGA pin of the XuLA board connects to each channel signal. (You can find this information in the StickIt! Board manual.)
- Make a UCF file associating each FPGA pin with an I/O pin of the module.
- Include the UCF file in your ISE project.

**That's a lot of work just to sample and output audio signals, so we've done most of it for you.** Just go to <http://github.com/xesscorp/StickIt>. There, you will find a subdirectory with a Xilinx ISE project that includes:

- a VHDL module that initializes the audio codec and provides an interface that accepts and delivers audio data as 20-bit words with a signal to synchronize the data transfers.
- a simple example design that digitizes a stereo audio source and then re-digitizes it and sends it back to a speaker or headphones.

# A.1 I/O Locations

The connections of the PMOD and Wing header I/O signals to the switches (S1 through S8) of the StickIt! Audio I/O module are shown below.

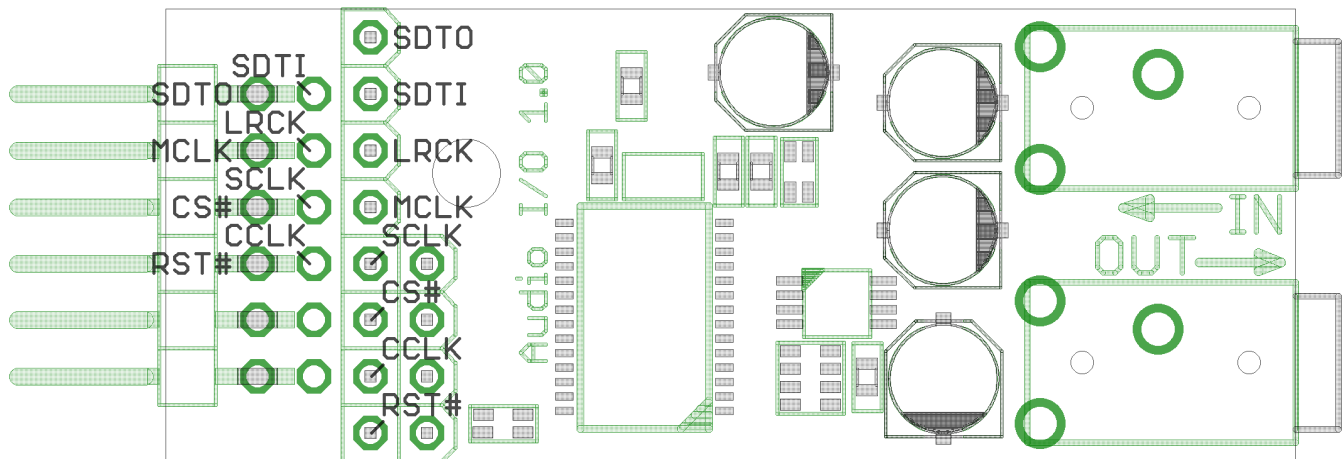

# A.2 Schematic

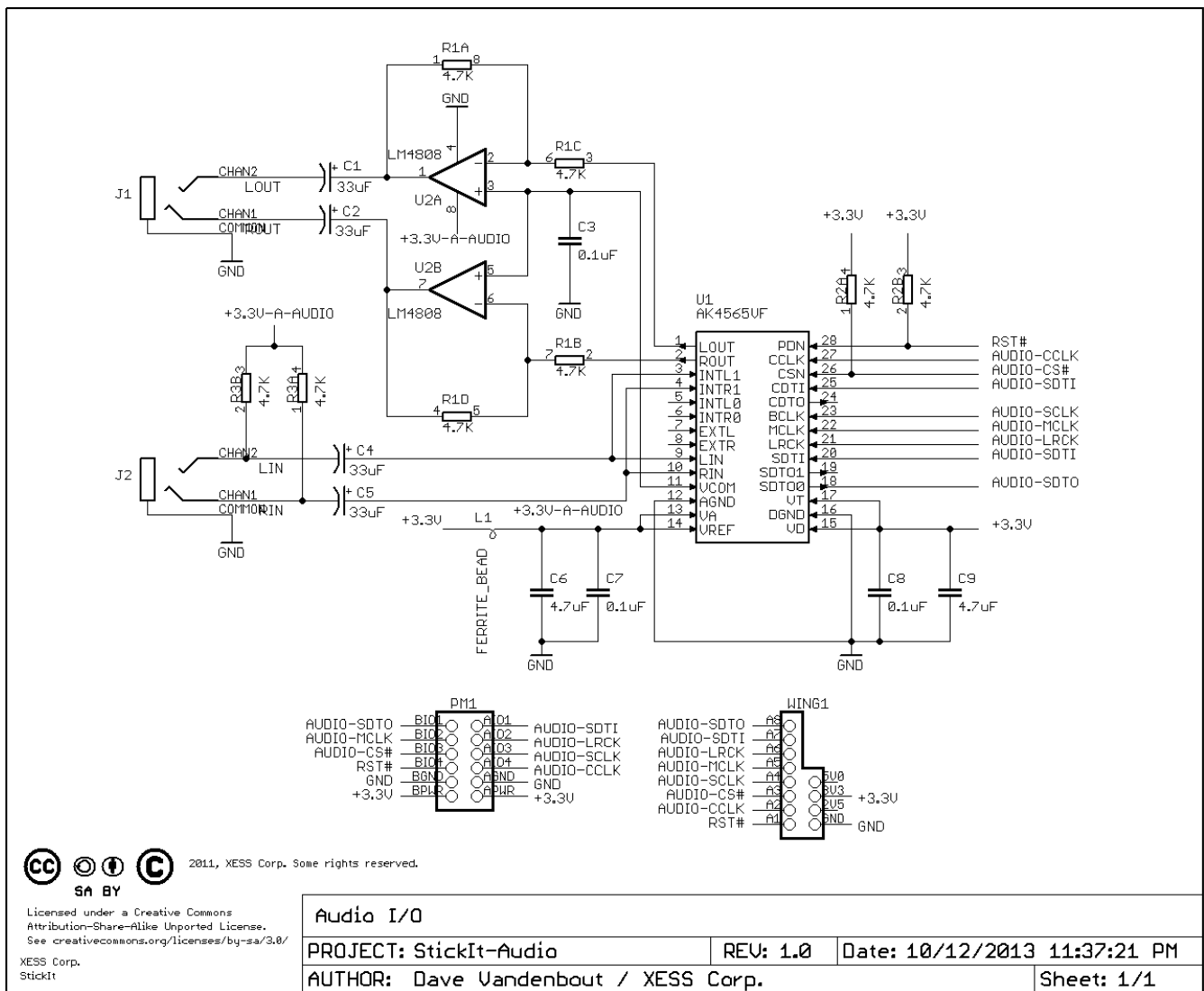

© 2011, XESS Corp. Some rights reserved.  
 Licensed under a Creative Commons Attribution-Share-Alike Unported License.  
 See [creativecommons.org/licenses/by-sa/3.0/](http://creativecommons.org/licenses/by-sa/3.0/)  
 XESS Corp.  
 StickIt

Audio I/O		
PROJECT: StickIt-Audio	REV: 1.0	Date: 10/12/2013 11:37:21 PM
AUTHOR: Dave Vandebout / XESS Corp.		Sheet: 1/1